

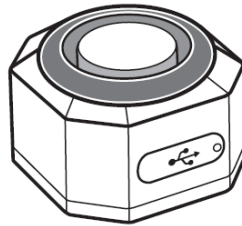

USER MANUAL – EN

IN 25329 Alarm with rear light inSPORTline Jolty



PRODUCT DESCRIPTION

- 1. Rear light
- 2. Speaker
- 3. 5V USB-C port
- 4. 2-part brackets
- 5. Silicone pad
- 6. Light type / pairing
- 7. Zip tie holder
- 8. Zip tie

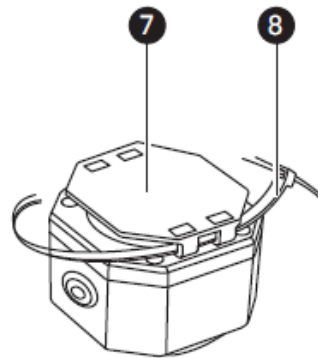
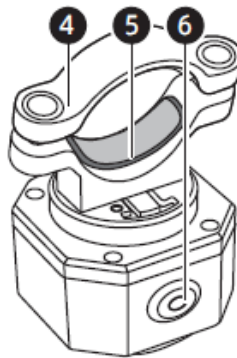
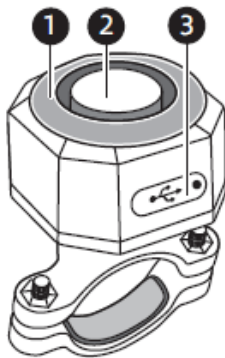

CONTROLLER

1. Turn on alarm	2. Turn off alarm
3. Turn on light	4. Alarm localization

INSTALLATION

Preparation before mounting

It is recommended that you charge the alarm before mounting.

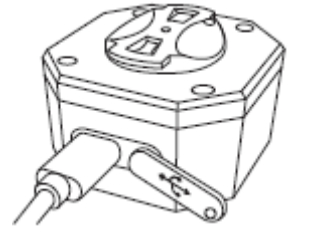
	<p>Note: Please use the supplied USB cable and 5V charging adapter (not included) to charge, some fast chargers may not be compatible</p>
---	--

Attaching the bracket

The bracket is suitable for bicycles, e-bikes or tricycles for mounting on a seat post, handlebars, rear holder or other type of tube with a suitable diameter.

Place the nuts.

Place the nut so that the part with the rubber ring faces outwards. Using a hard object, carefully fasten the nut into the bracket.

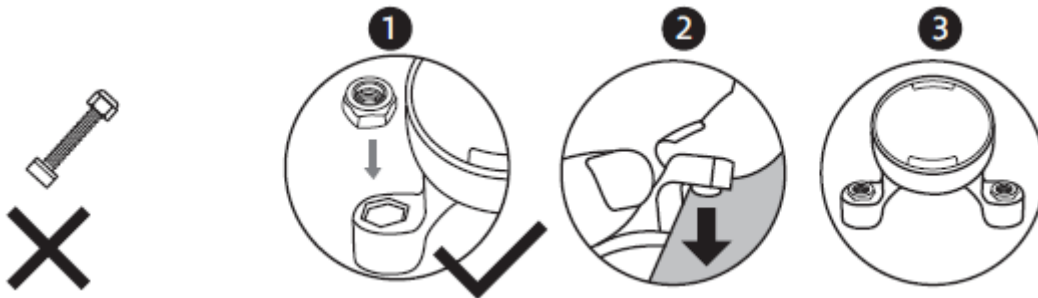

Attach the bracket to the back of the alarm by aligning it and then twisting it to attach it to the alarm, then screw it down.

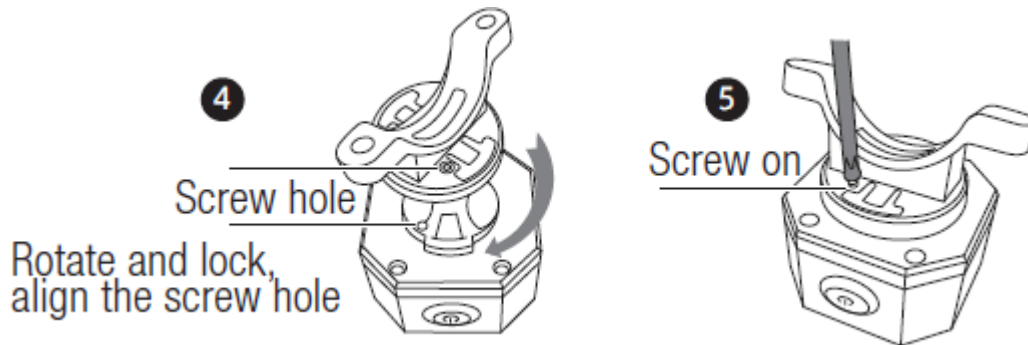

Attach the silicone pads to the insides of the bracket, place the bracket on the rod and screw in place. Check the screw tightness regularly.

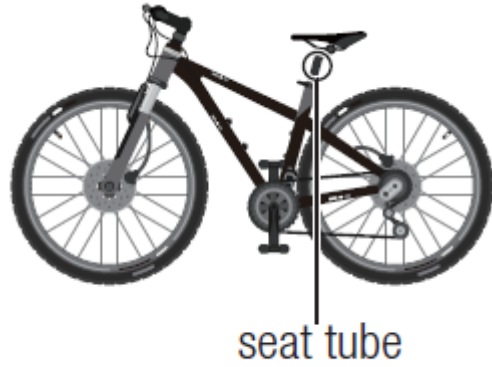
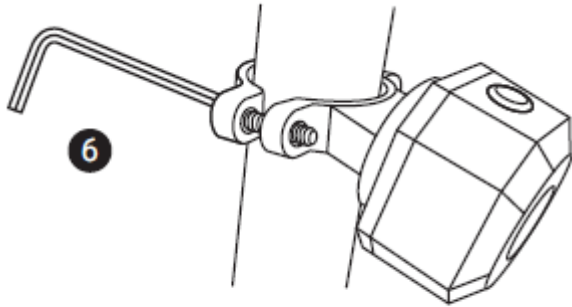

Place two part brackets on tube and tighten with screw

Note: We recommend mounting the alarm so that the USB port is facing down.

Note: Be careful and patient while fixing the nuts.

Fastening with zip tie

If the diameter of the holder is unsuitable, you can fix the alarm with zip tie.

Attach the zip tie holder, then thread the zip tie through and secure.

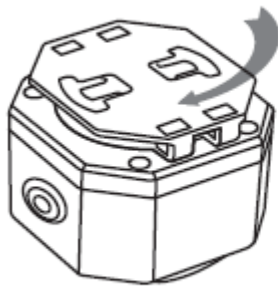

Rotate and lock

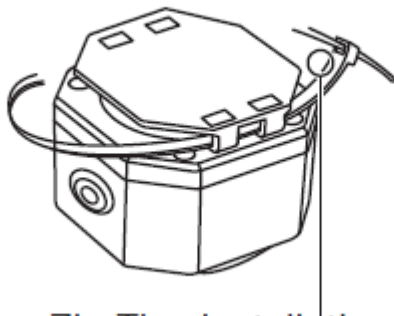

Zip Ties Installation



Installation position

Light settings

Turn off the alarm and with button  select one of 4 modes: slow flashing, breathing, flashing, steady light, off

Slow flashing and breathing modes have an intelligent trigger function. When activated, the light will turn on for 30 seconds, detect ambient lighting, and then automatically adjust to ambient light conditions. According to the surrounding light conditions, the light will automatically adjust the brightness to save battery. If you stop for more than 30 seconds, the light will turn off and turn on automatically while you ride.

If you don't want smart modes, you can choose flashing or constant light mode. These modes are not affected by ambient conditions and vibrations.

If the lights are on, they will illuminate brightly for 2 seconds during braking and then return to their previous light mode.

Alarm settings

Press , the alarm will be turned on and after 2 seconds an audible signal will sound, announcing the to be set. Once the alarm is set, it reacts to movement and vibrations in the

surroundings, vibrations or movement within 2 seconds, it will trigger a short acoustic notification. If constant movement or vibration is detected within 2-12 seconds. An alarm will sound for 30 seconds.

To turn off alarm press [] button, an audible signal will sound.

If you press [] button during the 2-second delay when the alarm is setting up, you cancel the alarm.

Other functions

Bike localization



By pressing [] you start the sound signal, the light turns on for 2 seconds.

Note: The function does not work if the alarm is set.



Sensitivity setting

The alarm can be set to 7 levels of sensitivity, each level is sound different, so the quietest is the lowest level and the loudest is the highest level. The factory setting is at the highest level.

To set the sensitivity, the alarm must be turned off.

1. Make sure that the alarm is turned off
2. Hold [], first there will be 2 sound signals, then a pause and hold until the diode on the controller turns off and lights up again and the sound signals will sound again.
3. Press [] button to select a sensitivity level. The sensitivity level is indicated by an audible signal. The louder it is, the higher the level.
4. Press [] to leave the settings.

Setting the bike localization melody

1. Make sure that the alarm is turned off
2. Hold [], first there will be 2 sound signals, then a pause and hold until the diode on the controller turns off and lights up again and the sound signals will sound again.
3. Press [] to select melody.
4. Press [] to leave the settings

If no operation is performed within 10 seconds, the setting will end and return to the current setting.

Indicator Light



Pairing with another controller

The controller you received for the alarm is already paired. The following steps are just in case you want to pair another controller.

1. Press the pairing button on the alarm for 2 seconds, you will hear a beep.
2. Press any button on the remote, the alarm will sound.
3. To exit the pairing mode, press the button on the alarm again or do no operation for 30 seconds.
4. A maximum of 8 controllers can be connected to the alarm at the same time.
5. If you want to delete all paired controllers, hold the pairing button on the alarm for 2 seconds until you hear a beep and then hold it for another 5 seconds. A beep will sound, and all controllers will be erased.

Battery charging

Alarm: If the alarm battery is low, when pressed  a audible signal will be sound. Open the USB cover and charge using the cable and 5V adapter (not included). The red indicator lights up during charging and turns off when the battery is fully charged.

Controller: With a weaker battery, the range of the controller decreases, the diode lights up dimly. Follow the steps below to replace the battery:

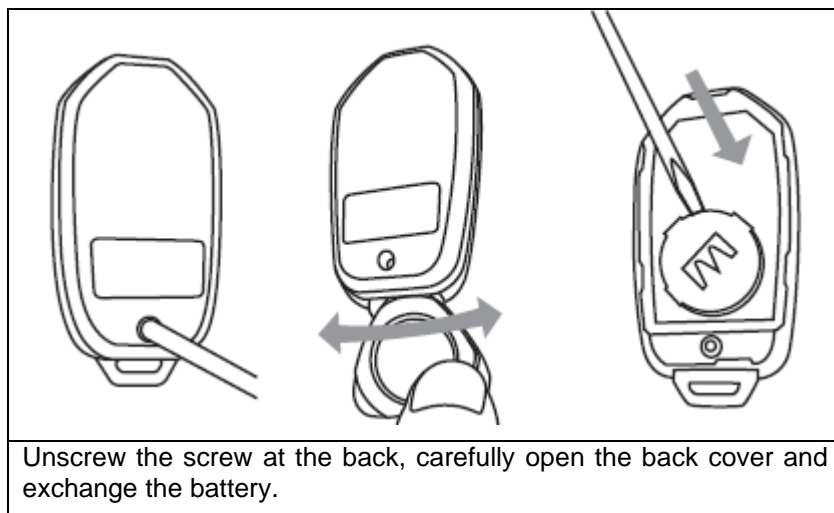

PARAMETERS

Alarm battery	3.7V, 700mAh lithium battery, operating time 1-3 months, in standby mode up to 6 months
Charging alarm	USB-C port, 5V, adapter not included, some fast chargers may not be compatible
Battery controller	CR2032(3V) Button battery, working time about 2-4 years
Operating frequency	433.92 MHz
Water resistance	IP65 waterproof and dustproof
Operating temperature	-40 to +70 °C
Operating humidity	<80%
Storage temperature	-40 to +70 °C

ENVIRONMENT PROTECTION

After the product lifespan expired or if the possible repairing is uneconomic, dispose it according to the local laws and environmentally friendly in the nearest scrapyard.

By proper disposal you will protect the environment and natural sources. Moreover, you can help protect human health. If you are not sure in correct disposing, ask local authorities to avoid law violation or sanctions.

Don't put the batteries among house waste but hand them in to the recycling place.

TERMS AND CONDITIONS OF WARRANTY, WARRANTY CLAIMS

General Conditions of Warranty and Definition of Terms

All Warranty Conditions stated here under determine Warranty Coverage and Warranty Claim Procedure. Conditions of Warranty and Warranty Claims are governed by Act No. 89/2012 Coll. Civil Code, and Act No. 634/1992 Coll., Consumer Protection, as amended, also in cases that are not specified by these Warranty rules.

The seller is SEVEN SPORT s.r.o. with its registered office in Strakonická street 1151/2c, Prague 150 00, Company Registration Number: 26847264, registered in the Trade Register at Regional Court in Prague, Section C, Insert No. 116888.

According to valid legal regulations it depends whether the Buyer is the End Customer or not.

"The Buyer who is the End Customer" or simply the "End Customer" is the legal entity that does not conclude and execute the Contract in order to run or promote his own trade or business activities.

"The Buyer who is not the End Customer" is a Businessman that buys Goods or uses services for the purpose of using the Goods or services for his own business activities. The Buyer conforms to the General Purchase Agreement and business conditions.

These Conditions of Warranty and Warranty Claims are an integral part of every Purchase Agreement made between the Seller and the Buyer. All Warranty Conditions are valid and binding, unless otherwise specified in the Purchase Agreement, in the Amendment to this Contract or in another written agreement.

Warranty Conditions

Warranty Period

The Seller provides the Buyer a 24 months Warranty for Goods Quality, unless otherwise specified in the Certificate of Warranty, Invoice, Bill of Delivery or other documents related to the Goods. The legal warranty period provided to the Consumer is not affected.

By the Warranty for Goods Quality, the Seller guarantees that the delivered Goods shall be, for a certain period of time, suitable for regular or contracted use, and that the Goods shall maintain its regular or contracted features.

Batteries

6-month battery warranty – we guarantee that battery's nominal capacity does not fall below 70% of its total capacity within 6 months of the product's sale.

The Warranty does not cover defects resulting from (if applicable):

- User's fault, i.e. product damage caused by unqualified repair work, improper assembly, insufficient insertion of seat post into frame, insufficient tightening of pedals and cranks
- Improper maintenance
- Mechanical damages
- Regular use (e.g. wearing out of rubber and plastic parts, moving mechanisms, joints, wear of brake pads/blocks, chain, tires, cassette/multi wheel etc.)
- Unavoidable event, natural disaster

- Adjustments made by unqualified person
- Improper maintenance, improper placement, damages caused by low or high temperature, water, inappropriate pressure, shocks, intentional changes in design or construction etc.

Warranty Claim Procedure

The Buyer is obliged to check the Goods delivered by the Seller immediately after taking the responsibility for the Goods and its damages, i.e. immediately after its delivery. The Buyer must check the Goods so that he discovers all the defects that can be discovered by such check.

When making a Warranty Claim the Buyer is obliged, on request of the Seller, to prove the purchase and validity of the claim by the Invoice or Bill of Delivery that includes the product's serial number, or eventually by the documents without the serial number. If the Buyer does not prove the validity of the Warranty Claim by these documents, the Seller has the right to reject the Warranty Claim.

If the Buyer gives notice of a defect that is not covered by the Warranty (e.g. in the case that the Warranty Conditions were not fulfilled or in the case of reporting the defect by mistake etc.), the Seller is eligible to require a compensation for all the costs arising from the repair. The cost shall be calculated according to the valid price list of services and transport costs.

If the Seller finds out (by testing) that the product is not damaged, the Warranty Claim is not accepted. The Seller reserves the right to claim a compensation for costs arising from the false Warranty Claim.

In case the Buyer makes a claim about the Goods that is legally covered by the Warranty provided by the Seller, the Seller shall fix the reported defects by means of repair or by the exchange of the damaged part or product for a new one. Based on the agreement of the Buyer, the Seller has the right to exchange the defected Goods for a fully compatible Goods of the same or better technical characteristics. The Seller is entitled to choose the form of the Warranty Claim Procedures described in this paragraph.

The Seller shall settle the Warranty Claim within 30 days after the delivery of the defective Goods, unless a longer period has been agreed upon. The day when the repaired or exchanged Goods is handed over to the Buyer is considered to be the day of the Warranty Claim settlement. When the Seller is not able to settle the Warranty Claim within the agreed period due to the specific nature of the Goods defect, he and the Buyer shall make an agreement about an alternative solution. In case such agreement is not made, the Seller is obliged to provide the Buyer with a financial compensation in the form of a refund.

CZ

SEVEN SPORT s.r.o.

Registered Office: Strakonická 1151/2c, Praha 5, 150 00, ČR
 Headquarters: Dělnická 957, Vítkov, 749 01
 Warranty & Service: Čermenská 486, Vítkov 749 01

CRN: 26847264
 VAT ID: CZ26847264

Phone: +420 556 300 970
 E-mail: eshop@insportline.cz
 reklamace@insportline.cz
 servis@insportline.cz

Web: www.inSPORTline.cz

SK

inSPORTline s.r.o.

Headquarters, warranty & service center: Električná 6471, Trenčín 911 01, SK

CRN: 36311723
 VAT ID: SK2020177082

Phone: +421(0)326 526 701
 E-mail: objednavky@insportline.sk
 reklamacie@insportline.sk
 servis@insportline.sk

Web: www.inSPORTline.sk